

Advances in Human Ecology, Vol. 6, 1997, pp. 1-47, Editor: Lee Freese Copyright 1997 JAI Press, Inc.

Email: information@philosophyofscience.net

Autocatakinetics, Evolution, and the Law of Maximum Entropy Production: A Principled Foundation Towards the Study of Human Ecology

[R. Swenson](#)

Center for the Ecological Study of Perception and Action, University of Connecticut

Abstract: Ecological science addresses the relations between living things and their environments, and the study of human ecology the particular case of humans. However, there is an opposing tradition built into the foundations of modern science which separates living things and particularly humans, from their environments. Beginning in modern times with Descartes' radical separation of psychology and physics (or "mind" from matter), this dualistic tradition was extended into biology with Kant's biology versus physics (or living thing versus environment) dualism, and into evolutionary theory with the rise of Darwinism and its grounding in Boltzmannian thermodynamics. If ecological science is to be about what it purports to be about, about living thing-environment relations, it must provide a principled basis for dissolving Cartesian incommensurability. A deeper understanding of thermodynamic law, and the principles of self-organizing ("autocatakinetic") systems provides the nomological basis for doing just this, for putting evolution back in its universal context, and showing the reciprocal relation between living things and their environments, thereby providing a principled foundation for ecological science in general, and human ecology in particular.

INTRODUCTION

The word "ecology" was coined by Haeckel, and used in his *Generelle Morphologie* in 1866 to refer to the science of the relations between living things and their environments (Bramwell, 1989), and human-environment relations, by this general definition, constitute the central subject of human ecology. The idea of the separation of humans from their environments, however, is deeply embedded in the foundations of modern science. It was Descartes, who, promoting a psychology vs. physics dualism where the active, epistemic part of the world (human "minds") was incommensurably separated from what was taken to be the "dead", mechanical, physical part of the world ("matter" or "other"), provided the world view that became the basis of modern science, and which, at the same time, supernaturally separated humans from the world (see also Dyke, this volume).

Later, arguing that the active end-directed striving of living things in general could not be accounted for within the dead, mechanical world of physics, Kant, calling for the autonomy of biology from physics, promoted a second major dualism, the dualism between biology and physics, or between living things in general (not just human minds) and their environments ([Swenson & Turvey, 1991](#)). The Cartesian tradition was carried into evolutionary theory with the ascendancy of Darwinism, which, making no use of physics in its theory, provided an explanatory framework where "organisms and environments," in Lewontin's (1992, p. 108) words, "were totally separated." Strong apparent scientific justification for these postulates of incommensurability came with Boltzmann's view of the second law of thermodynamics (the "entropy law") as a law of disorder—a hypothesis which he developed during the last quarter of the last century in an attempt to save the Cartesian, or mechanical, world view.

According to Boltzmann, physical systems are expected to become increasingly disordered or run down with time, and the spontaneous transformation of disordered to ordered states is "infinitely improbable" (Boltzmann, 1886/1974, p. 20). This view effectively set living things, as expressed, for example, in the fecundity principle, perhaps the *sine qua non* of Darwinian theory (the idea that life acts to produce as much biological order as it can), and in the progressive ordering that characterizes the evolution of life on Earth as a whole (from bacterial ecosystems some four billion years ago [4 GYA] to the rise of civilizations and the global proliferation of culture going on today), against the apparent otherwise universal laws of physics. The world, on this view, was supposed to be running down according to the laws of physics, but biological and cultural systems seemed to be about "running up"—not about going from more orderly to less orderly states, but about producing as much order as possible. It is "no surprise," under these circumstances, in the words of Levins and Lewontin (1985, p. 19), "that evolutionists [came to] believe organic evolution to be a negation of physical evolution." As Fisher (1930/1958, p. 39), one of the founders of neo Darwinism expressed it, "entropy changes lead to a progressive disorganization of the physical world...while evolutionary changes [produce] progressively higher organization." This view is still found at the foundations of the Darwinian view today, as evidenced by [Dennett's](#) (1995, p. 69) definition of living things as things that "defy" the second law of thermodynamics.

Cartesian incommensurability precludes an ecological science, and as a consequence, ecological science, if it is to be about what it purports to be about, about living thing environment relations, requires a theory that dissolves it. The postulates of incommensurability came into modern science on the issue of the active, epistemic dimension of the world, and this is precisely the battle ground where they must be defeated. In particular, the confrontation must occur at the interface of physics, psychology, and biology, and the distinguishing characteristic of this interface

is that it is defined by intentional dynamics, the dynamics that, not coincidentally for ecological science, distinguishes the living thing-environment relation. By intentional dynamics, I refer to end-directed behavior prospectively controlled, or determined, by meaning, or information about (of which "end-in-mind" behavior is a lately evolved kind).

Rivers flowing down slopes, or heat flowing down temperature gradients from hot to cold, for example, are end directed systems, but they are not examples of intentional dynamics because they do not require meaningful relations to determine the paths to their ends. Their behavior is explicable in terms of local energy potentials and fundamental physical laws. In contrast, when a bacterium swims up a concentration gradient, a bird flies above the Earth, or opens its wings to effect a landing on a branch, a human drives a car, puts a satellite in orbit around the Earth, or moves some food from her plate to her mouth, this behavior is seen to go in directions that are different from, and oftentimes opposite, those that follow causally from local physical potentials and laws. This kind of end directed behavior, the kind that is meaningfully, or epistemically determined with respect to non-local potentials, is what characterizes intentional dynamics. Terrestrial evolution shows the world to be in the order production business, characterized, not by progressive disordering to equilibrium, but by the production of increasingly higher states of order, and the way the production, to use Calvin's (1986) felicitous phrase, of this "river that flows uphill" takes place is through meaningful, or epistemic relations (see Figure 1).

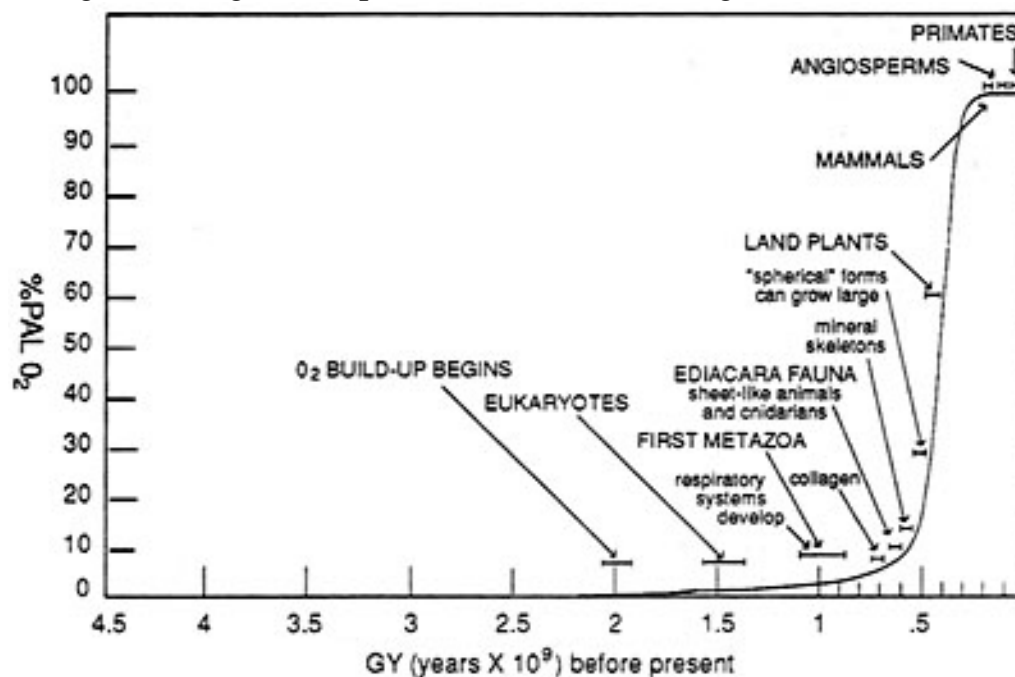

Figure 1. The production of progressively higher states of order as function of increasing levels of atmospheric O₂ in geological time (PAL is present atmospheric level). Atmospheric oxygen was put into the atmosphere by life, and has been maintained at present levels for some hundreds of millions of years by life at the planetary level. The transformation of the Earth's atmosphere from oxygenless to oxygen-rich, as well as the forms, including human cultural systems, that have systematically arisen as a consequence of it, are measures of the terrestrial system's departure from thermodynamic equilibrium, or progressive ordering. This runs counter to the widespread conception of the second law of thermodynamics due to Boltzmann which predicts that the world should be becoming increasingly disordered. This has led evolutionists to believe that biological, and cultural evolution defy or negate physical evolution, a belief, in effect, of two incommensurable "rivers", the river of physics which flows down to disorder, and the river of biology, psychology, and culture which flows up. From "Engineering Initial Conditions in a Self-Producing Environment" by R. Swenson, in M. Rogers and N. Warren, eds., *A Delicate Balance: Technics, Culture and Consequences*, p. 71, 1989a, Los Angeles, CA: Institute of Electronic Engineers (IEEE). Copyright 1989 by IEEE. Reprinted by permission.

Swenson: *Advances in Human Ecology*, Vol. 6, 1997

Continuing the metaphor, and summarizing by restatement in different terms what has been said above, if ecological science is to be ecological in more than name only, it must provide a principled basis for unifying what are otherwise taken to be two incommensurable rivers—the river of physics that flows downhill, and the river of biology, psychology, and culture that flows uphill. The absence of such a principled account invites the otherwise recurrent problem of the Presocratic Parmenides who had a fully coherent theory of the world which, however, could neither account for, nor even accommodate, his own existence. Recent advances in the theory of thermodynamics and self-organizing systems provide the basis for dissolving the postulates of incommensurability—for providing the nomological basis for intention and intension in a physical world otherwise taken to be collapsing to disorder, and inherently meaningless (defined exhaustively by extension). Rather than being anomalous with respect to, or somehow defying or going against universal laws, the intentional dynamics of living things are seen to be a direct manifestation of them. This provides a principled basis for setting the active ordering characterizing the evolution of life, from Archean prokaryotes to the present rapid globalization of culture, in its universal context, and in so doing provide a principled foundation for ecological science in general, and human ecology, in particular.

THE CARTESIAN CIRCLE, AND THE FIRST POSTULATE OF INCOMMENSURABILITY

The influence of Descartes, whose ideas were built into modern science at its origins, is hard to overestimate. Although the physics of Newton eclipsed the physics of Descartes it was the latter's dualistic metaphysics that provided the ground on which the former was able to flourish, and because psychology and physics were defined at their modern origins by Descartes, he is often referred to not only as the father of modern philosophy but the father of modern psychology and physics as well. What Cartesianism effected with its dead mechanical, or clock-work, world view was a means for the religious authority of Descartes' time to see science within a context it could accept, and for humans to see themselves, in the words of Descartes (1637/1986, p.67), as "masters and possessors of nature". Humans were taken to be sitting dualistically outside the clock like world learning the laws of physics to manipulate them towards their own, and hence, as privileged creations on Earth, divine ends. There was no theory of cultural ordering, or evolution in general, on this view because humans and the static mechanical physical world they were said to inhabit were taken to have been created full blown by divine act.

Cartesianism Defined The Epistemic Dimension Out Of The Physical World

A fundamental point to make with respect to the Cartesian world view is that by defining physics and psychology by their mutual exclusivity (call this the "first postulate of incommensurability" [[Swenson, 1996](#)]) it literally defined the active epistemic dimension out of the physical part of the world altogether. According to Descartes, the world was said to be divided into an active, purposive, perceiving "mind" (the "free soul", "thinking I," "Cartesian ego," or "self") on the one hand (the psychological part), and passive, "dead", purposeless "matter" (the physical part) on the

other. The physical part, defined exclusively by its extension in space and time, was seen to consist of reversible, qualityless, inert particles governed by deterministic causal laws from which the striving mind, seen as active, boundless, and without spatial or temporal dimension, was said to be immune. An immediate implicate of this view was that spontaneous ordering in general, and intentionality and meaning in particular, were thus eliminated from the physical world by definition, and needed to be extra-physically imposed from the outside. For Newton, Boyle, and other believers in Descartes mechanical world view who took the world to be extra-physically ordered by God, this was not a problem, but instead a reaffirmation of their belief.

The Problem Of Dualist Interactionism

Even if such a world were extra-physically given, there is an insurmountable problem with respect to how such a system could ever possibly work, and this was recognized almost immediately by many of Descartes own followers even in his own time. This is the problem of dualist interactionism. In particular, if psychology and physics ("mind" and "matter", or "self" and "other") are dualistically defined the way Descartes did by their mutual exclusivity there is no way, in fact, that they could ever interact. Leibniz recognized this central problem of Cartesianism by anticipating the law of energy conservation (the first law of thermodynamics). For one thing to interact with another, he argued, requires something conserved over the interaction, and if something is conserved over the two things or processes they are, at some level, part of the same thing. "There must be something which changes, and something which remains unchanged," wrote Leibniz (1714/1953, p. 27), anticipating, it could be argued, the second law of thermodynamics too. Without a conservation, the point is here, the two would be truly incommensurable two separate worlds without any possible relation or causal connection.

This separateness of the physical and mental was reinforced by Descartes theory of perception, and his famous *cogito ego sum* that what is known indubitably is the self reflective mind perceiving itself. The indubitability of matter, for Descartes, was not so clear, and with mind ultimately perceiving itself (the physical world exhaustively defined by extension is not in the category of mental or meaningful things), and his strong claim as to what is known, or what might exist, therefore, did not include an "outside" world at all. The epistemic dimension of the world, on Cartesian principles, it was soon realized, became a closed "Cartesian circle" with no way in or out, the immaterial mind perceiving itself, and no grounds to assert meaningful relations with, or the existence of, anything outside the individual self, ego, or self-motivating, self-reflective mind no environment at all, in effect, the active epistemic act, the subjective, simply given. It is seen with little elaboration that this view is inimical to a theory of ecological relations.

Closed-Circle Theory, Cultural Ordering, And The Epistemic Dimension

It is not surprising that post-Cartesian theories of knowledge, intentionality or meaning would become linked, explicitly or not, with theories of culture and evolution. Culture is clearly an epistemic process effected by meaningful relations, and the epistemic process itself would clearly seem to be evolutionary. What is interesting, however, is that post Cartesian theories of knowledge are typically seen to be allied with either cultural or evolutionary accounts as two competing paradigms, the work of the later Wittgenstein, Kuhn and others being exemplars of the first, and that of Popper, Campbell, Lorenz and others being exemplars of the second (Munz, 1985, 1987).

Supporters of the first view ("closed-circle theorists"), who have worn incommensurability and relativism almost as a kind of badge of enlightenment, look to sociology or social psychology as the basis for meaning and intentionality, while evolutionary epistemologists, supporters of the second view, look to evolutionary theory, or, more particularly, to Darwinian theory, as the ground for the epistemic dimension. In this sub section, I will briefly review the former. The latter will be discussed in the context of the next section dealing specifically with evolution.

The roots of closed-circle theory can be found in Durkheim and Malinowski, in the "sociology of knowledge" of Mannheim, and earlier in Marx and Engels' work on ideology, and in Spencer's work before them. All of these, however, should not be construed as closed-circle theorists in the extremized post modern sense of Wittgenstein and Kuhn. The common thread that unites this lineage is that cultural ordering is seen to determine individual action. This core idea was later associated with what came to be known as "functionalism" in contrast to what is sometimes called "psychologism", the idea that cultural systems are rational constructions of individual intentional agents. On the former view, rather than culture being taken as the rational construction of individuals, individuals, instead, are taken as component productions of cultural systems. The contributions of the functionalists were substantial in that they recognized cultural system as self-organizing systems. The problem, however, was that they had no theory of self organization.

Malinowski, in explicit reaction to psychologism, as well as the then prevalent evolutionary views of history or culture, held that cultural systems were effectively closed circles where the parts all function to maintain the whole. Given that, on this view, the circular relations that define the system are seen to refer back to themselves<that the function of the system is to maintain itself<cultural systems were said to exist *sui generis*. Everything is explained with respect to something else that happens internal to the circular relations of the system. Here we see the beginnings of the transposition of the Cartesian circle from the individual to the cultural or social psychological level.

Swenson: Advances in Human Ecology, Vol. 6, 1997

Wittgenstein took this latent idea of cultural Cartesianism, and made it more explicit. The epistemic dimension of the world, rather than constituted through the self-referential circular relations of the individual human mind as it was for Descartes, was constituted through the intersubjective circular relations of humans within a cultural system. Meanings, said Wittgenstein, are formulated and stated in "language games" consisting of a set of rules that constitute closed circles of meanings. There are no individual meanings because there is no individual language, and because such systems are closed circles there can be no ostensive pointing or reference to anything outside the system (i.e., an objective "world"). What is more, because meaning is entirely relative to the rules of each system, and thus meaning invariance across cultural systems is denied, such circles of meaning are incommensurable with respect to each other. Truth thus varies from one closed circle to the next, and can only be measured with respect to the rules, or authority, of a particular community.

In the influential history and philosophy of science of Kuhn, Wittgenstein's closed-circle language games were turned into paradigms, and the history of science seen as the shift from one paradigm to another (scientific revolutions). Because reality is taken to be the ideal construction of human cognizers operating under particular paradigms, and since paradigms as closed circles are incommensurable with each other, there is no way to talk of progress in science, a direction in time, or advancement from one paradigm shift or revolution to the next. Without meaning invariance there is no way to make a comparison. On this view, Einstein's physics, for example, does not subsume or explain Newton's but is simply different. Neither one is "truer" than the other—they are simply incommensurable. The post modern structuralism of Foucault, Derrida, and the post-modern pragmatism of Rorty, which uses Foucault, in effect, to justify Wittgenstein (Munz, 1987), are all closed circle theories that share the common premises of the relativity of meaning to circularly closed systems, and the incommensurability of such systems with respect to each other and an external world. Closed-circle theory carries forward the anti-realist position of positivism, but at the same time challenges its rationality.

While closed-circle theory is often given as a kind of enlightened alternative to modernism, it is itself modernism carried to a certain post-Humean, post-Kantian, extremized conclusion—the Cartesian core is still there only wrapped in sociological packaging, and regressed from the individual to cultural level. The most severe problems fall into three main areas:

1) Closed-Circle Theory Is Anti-Evolutionary

The first main problem area concerns the fact that because closed circles are incommensurable with respect to each other there is no way to assert that they are part of an evolutionary process, or that any such process even exists. There is no way to provide an ordinal measure with respect to time. Closed-circle theory is time-symmetric. From the view of closed-circle theory, Einstein's theory could just as well have preceded Newton's, the theory of oxygen could have preceded the theory of phlogiston, the theory of heat, and the conservation of energy could have preceded the caloric, and the periodic table of elements might just as well have come before the theory that earth, fire, air, and water constituted the basic elements. Closed-circle theory thus fails to recognize, or account for evolutionary dynamics (or cares too), and this includes the active, and expansive nature of the epistemic act, or epistemic dimension, itself. This anti-evolutionary foundation is underpinned by the

intersubjective idealism of closed-circle theory which extends, and extremizes the Cartesian-Kantian anti-ecological tradition of effectively putting humans at the center of the universe.

2) *Closed-Circle Theory Invokes An Illegitimate Teleology*

The second main problem area is the illegitimate teleology at the core of closed-circle theory. Closed-circle theory, including its functionalist ancestors, by making the fundamental reality the circular relations that define a cultural system, substitute formal causality (the form, or shape of a thing, in this case the circular relations) for the usual efficient cause that constitutes the usual notion of causality in modern science (e.g., such as that found in various bottom-up rationalist schemes such as "psychologism", or in billiard-ball mechanical models in physics). Cultural systems, are seen to be self-organizing systems of sorts, that function, in the production of their components or component relations towards their own ends, which, in particular, is to maintain themselves. This takes causality beyond the simple efficient causes of mechanical reductionism (it adds a kind of formal causality), but from the ground of modern science from which it starts, and for which no replacement theory is offered, there is no principled basis provided for where such ends or end-directed behavior can come from. The ends simply point back to themselves, and this is precisely the problem that discredited virtually every one of closed-circle theory's functionalist ancestor's before it (Swenson, 1990; Turner and Maryanski, 1979). The teleology of closed-circle theory is thus more of a kind of religious than scientific assertion. It requires defeating some widely held scientific assumptions, but provides no principled basis for doing so.

In particular, downward causality has traditionally been rejected by biology, on the one hand, because it does not fit into the explanatory framework of natural selection, which, as will be discussed more fully below, does not include populations of one, and by physics, on the other, because downward causality constitutes macroscopic ordering in a world which according to the received view of thermodynamics, should be collapsing to microscopic disorder. In addition, no matter how it is assumed closed-circles get ordered in the first place, the fact that they remain so *sui generis*, or without outside relations or ostensive pointing, makes them perpetual motion machines of the second kind, a flight in the face of what many (e.g., Eddington, 1958) have called the most fundamental and unbreakable of all the laws of physics.

3) *The Intersubjectivity At The Core Of Closed-Circle Theory Begs The Old Cartesian Questions And Doubles The Problem*

The third main problem area is that the intersubjectivity at the core of closed-circle theory begs the old Cartesian questions, and simply regresses, or doubles, the problem. Briefly put, meanings for the closed circle theorist exist in the persistent and invariant relations constituted through the intersubjective relations that define the closed circle. To each individual, however, this requires persistent and invariant relations with a world outside herself or himself, and this requires a non-Cartesian theory of perception. In short, the intersubjectivity of closed-circle theory requires breaking the Cartesian circle at the individual level since the individual mind is no longer simply perceiving itself, but something external in relation to which it comes to be determined or defined, and this requires a commensurability between knower and known which undercuts the ground of closed-circle theory. Once the individual Cartesian circle is broken, there is no principled basis to maintain the cultural one (viz., one has admitted the fundamental existence of a self-other relation, there is no principled basis to confine this only to other humans).

EVOLUTIONARY EPISTEMOLOGY, ECOLOGICAL SCIENCE, AND THE PROBLEM(S) WITH DARWINISM AS THE THEORY OF EVOLUTION

The Second Postulate of Incommensurability

Cartesian metaphysics, as noted above, came full-blown into modern biology with Kant who argued correctly that the active striving of living things could not be fathomed as part of a dead, reversible mechanical world. Rather than questioning the impoverished physics, however, he called for a second major dualism, the dualism between biology and physics, or between living things and their environments (call this the "second postulate of incommensurability" [Swenson, 1996]). The argument, grounded on the view of the incommensurability between the active, striving, intentional dynamics of living things and their "dead" environments, is still promoted today by leading proponents of Darwinian theory (e.g., Mayr, 1985). Boltzmann's interpretation or hypothesis of the second law of thermodynamics has played a crucial role, as already noted, in giving apparent legitimacy to the view that physics has nothing to say to biology, its principles being not simply foreign, but hostile to it. Darwinian theory, from its beginning with Darwin had little use for physics in its theory. Darwin, in Lewontin's (1992, p. 108) "completely rejected [the] world view...that what was outside and what was inside were part of the same whole system..." thereby carrying the anti-ecological Cartesian-Kantian postulates directly into evolutionary theory, and making it as inimical to ecological science as its ancestral relatives.

Evolutionary epistemologists, as noted in the preceding section, have a view almost directly opposite to that of the closed-circle theorists (e.g., see Callebaut & Pinxten, 1987; Radnitzky & Bartley, 1987). Whereas closed-circle theorists such as Wittgenstein and Kuhn are arch anti-evolutionists, evolutionary epistemologists look to evolutionary theory, in particular, Darwinian theory, to provide an account of the epistemic dimension. Evolution, on this view, is taken to be a continuous, and progressive knowledge acquisition process, in Popper's words, "from amoeba to man" following from natural selection. Every living thing, according to this view, has knowledge in the expectations on which its intentional behavior depends, and this knowledge, as a consequence of natural selection, is taken to be true (hypothetically) since if not, to put it simply, the living thing in question would be dead. While true knowledge to the closed-circle theorist follows from cultural authority under a particular paradigm, to the evolutionary epistemologist it is determined with respect to the performance of an epistemic agent in the world. Scientific knowledge is seen to be continuous with evolution by natural selection since it too involves a trial and error process of selection through the proposal and refutation of falsifiable hypotheses (Campbell, 1987).

The problem with evolutionary epistemology is its reliance on Darwinian theory. Darwinism's Cartesian postulates eliminate it *a priori* from the task that evolutionary epistemologists would like to have it perform. More specifically, two immediate problems, either of which by itself would be sufficient to disqualify Darwinian theory with respect to providing an account of the epistemic dimension can be quickly given. They will only be mentioned here, but will be discussed in more detail with the other "big" problems of evolution below. The first is that Darwinian theory assumes intentional dynamics to begin with, and this puts an explanation of intentional dynamics outside its theory. The second, is that the claim that evolution is a progressive knowledge acquisition process is an assertion that can neither be made nor explained from the ground of Darwinian theory because the relevant observable (fitness) is relativized to members of breeding populations. These and the other problems below can all be seen to follow from the position evolutionary theory has backed itself into

as a consequence of the Cartesian postulates at its core.

General Versus Specific Theories Of Evolution

The dream of uniting the two apparently opposing rivers, it should be noted, did not escape Fisher (1930/1958, p. 39), who imagined that the two apparently opposing directions of biology and physics "may ultimately be absorbed by a more general principle." Lorenz (1973, p. 20), one of the founders of evolutionary epistemology wrote that the aspect of life "most in need of explanation, is that, in apparent contradiction to the laws of probability, it seems to develop from ...the more probable to the less probable, from systems of lower order to systems of higher order." For Spencer (e.g., 1857/1892, 1862), who defined the term "evolution", and popularized the idea in numerous best-selling books prior to Darwin, biological evolution was part of a more general universal process of evolution. He defined evolution as a process of the transformation of less ordered to more ordered states following from natural law (the "law of evolution"). Although Spencer was never able to supply the physical basis for his law of evolution, as a consequence of its asserted, if not demonstrated, nomological continuity (viz., biological ordering was seen as a special case of universal ordering), his general theory of evolution, an early statement of evolution as a law-based self-organizing process, was at least an attempt at a commensurable rather than incommensurable theory.

It was with the ascendancy of Darwinism that evolution was taken out of its universal context, and the meaning of the term reduced to biological evolution alone (see also Swenson, 1991b, 1992, 1996, in press-a, [in press-b](#)). According to Mayr (1980, p. 12), the "almost universally adopted definition of evolution [today] is a change of gene frequencies" following from natural selection, the "final implementation" of the basic Darwinian concept except that the focus was shifted by neo-Darwinism from organisms to genes. It was with the reduction of the meaning of the term evolution from a universal to a biological process that the Cartesian-Kantian postulates were built into the core of evolutionary discourse, and with them the major anomalies of Darwinian theory. These are not simply the problems of evolution, but true anomalies with respect to Darwinian theory because, as will be seen, they are problems that its core postulates preclude it from answering.

The Problem(s) With Darwinism As The Theory of Evolution

Six main problems are as follows:

1) Natural Selection Requires The Intentional Dynamics Of Living Things In Order To Work, And This Puts The Intentional Dynamics Of Living Things Outside The Explanatory Framework Of Darwinian Theory.

The core explanatory concept of Darwinian theory in all its various forms is natural selection (Depew and Weber, 1995). Evolution, according to Darwinism, follows from natural selection and natural selection is entailed by a situational logic (Popper, 1985) if certain conditions hold then natural selection will necessarily follow. These conditions are heritable variation, finite resources and the fecundity principle, a biological extremum principle that captures the active striving of living things. Natural selection, said Darwin (1959/1937, p. 152), follows from a population of replicating or reproducing entities with variation "striving to seize on every unoccupied or less well occupied space in the economy of nature". Because "every organic being," he said (Darwin, 1959/1937, p. 266), is

"striving its utmost to increase, there is therefore the strongest possible power tending to make each site support as much life as possible." Paraphrasing Darwin, in Schweber's (1985, p. 38) words, the fecundity principle, which refers to the intentional dynamics of living things, thus says that nature acts to "maximizes the amount of life per unit area" given the constraints. But notice that the situational logic from which natural selection follows makes natural selection dependent on the intentional dynamics of living things; natural selection does not explain the intentional dynamics of living things, it is a consequence of them, and this puts intentional dynamics outside the explanatory framework of Darwinian theory.

2) Darwinism Has No Observables By Which It Can Address Or Account For The Directed Nature Of Evolution

That evolution is a progressive or directed process (meaning going in a direction) is seen in the cited statements of Fisher, Lorenz, and is evident to anyone who looks at the planetary evolutionary record (e.g., see Figure 1). It is a core idea for evolutionary epistemology which sees evolution as a progressive knowledge acquisition process, per Popper, from "amoeba to Einstein" where the knowledge of a thing has is measured by its "fitness". But Darwinism, which, in effect, is a time-symmetric theory, has no observables that can be used to measure the direction of evolution at all, and this, in particular, includes fitness. Because fitness is relativized to members of breeding populations, the fitnesses of different kinds of things, as in the case with closed circles in closed-circle theory, are incommensurable with respect to each other, and cannot be compared (e.g., Fisher, 1930/1958; Sober, 1984). A zebra who runs faster than another zebra, avoids predators better, and thus produces more offspring, can be said to be more fit than the slower zebra, but a zebra can not be compared on the same basis to a mouse, or an amoeba. Mice can only be judged more or less fit than other mice, and amoebas with respect to other amoebas, and this makes fitness an incommensurable observable with respect to evolution writ large. Darwinian theory has no ground from which to measure, or account for, the directed nature of evolution, and no ground, in particular, for evolutionary epistemology to claim evolution as a progressive knowledge acquisition process. To justify this claim would require evolution to be about something other than fitness.

3) Because Natural Selection Works On A Competitive Population Of Many, And The Earth, As A Planetary System Evolves As A Population Of One, Darwinian Theory Can Neither Recognize Nor Address This Planetary Evolution

One of the most important empirical facts that has come to be recognized in recent decades is that the Earth at the planetary level evolves as a single global entity (e.g., Cloud, 1988; Margulis & Lovelock, 1974; Schwartzman, et al., 1994; [Swenson & Turvey, 1991](#); Vernadsky, 1986/1929), and the present oxygen rich atmosphere, put in place and maintained by life over geological time, is perhaps the most obvious *prima facie* evidence for the existence and persistence of it (see Figure 1). With the shift of the Earth's redox state from reducing to oxidative some two billion years ago evolution undeniably became a coherent planetary process. Because the evolution, development, and persistence of all higher-order life has depended and continues to depend on the prior existence and persistence of evolution at the planetary level, this single planetary system may well be considered the fundamental unit of terrestrial evolution. Without question an understanding of planetary evolution is fundamental to evolutionary theory, to ecological science, and to a theory of cultural evolution and human ecology. Yet this poses a major problem for Darwinian theory because the planetary system as

a whole cannot, by definition, be considered a unit of Darwinian evolution (Dawkins, 1982; Maynard-Smith, 1988). Darwinian theory, which defines evolution as the consequence of natural selection acting on a competitive replicating or reproducing population of many cannot address or even recognize planetary evolution because there is no replicating or reproducing population of competing Earth systems on which natural selection can act. The Earth evolves as a population of one. Natural selection is seen to be a process internal to the evolution of the planetary system, and thus rather than explaining terrestrial evolution, it awaits an explanation of planetary evolution by which it, as a manifestation, might be explained (Swenson, 1991a).

4) Darwinian Theory Has No Account Of The Insensitivity To Initial Conditions (Like Consequents From Unlike Antecedents) Required To Account For The Reliability Of Intentional Dynamics Or The Evolutionary Record Writ Large

Contemporary Darwinian theory is characterized by a commitment to the assumptions of gradualism, continuous change, reductionism, and efficient, or mechanical cause. The dynamics of its theory are based on the difficult (if not impossible) marriage of a kind of Laplacean determinism, namely, that like antecedents produce like consequents<that, for example, if the initial conditions or microconditions are changed the macroscopic dynamics will be different, and the belief, at the same time, that there exists a certain amount of microscopic randomness, variation, or "error" in the world. The latter is supported by the most widely held views of quantum mechanics (viz., that probability is, in fact, objective). The consequence of these assumptions, for example, with respect to terrestrial evolution writ large is that it is seen as a process where, in effect, "anything goes", and that, given the fact of microscopic randomness, if one rewound the tape of evolutionary history back to some point in the distant past and played it again, it would turn out "entirely different" every time one rewound the tape (e.g., Gould, 1989; Williams, 1992, p. 3). Yet if such a micro-macro relation were true, if living things were sensitive to initial conditions in this way, the characteristic properties of terrestrial evolution writ large, and, in particular the intentional dynamics of living things, would be inconceivable. Real-world systems of this kind show a remarkable insensitivity to initial conditions<they are "end-specific" not "start-specific" to use Dyke's (this volume) felicitous terms. They repeatedly produce the same end states from different initial conditions, and they are required to do so in order to survive because, regardless of the ultimate facts of quantum mechanics, real-world initial conditions are never the same twice. This remarkable insensitivity to initial conditions on which terrestrial evolution as we know it depends is unrecognized and unaccounted for by Darwinian theory.

5) The Incommensurability Between Biology And Physics Assumed By Darwinian Theory Provides No Basis Within The Theory According To Which Epistemic Or Meaningful Relations Between Living Things And Their Environments Can Take Place

The fecundity principle on which evolution on the Darwinian view crucially depends assumes the active intentional dynamics of living things<it assumes the meaningful determination of the end-directed behavior of living things. Given the Cartesian psychology or theory of perception at the core of Darwinian theory, however<the rejection by Darwinism that what is inside and what is outside are part of the same whole system (Lewontin, 1992), there is no principled basis for meaningful relations to take place. The outside or physical world is a world of extension, while the inside world, the biological or psychological part of the world is a world of intension, and this re-creates the Cartesian problem of dualist interactionism. An ecological science requires an ecological evolutionary theory,

and such a theory requires a non-Cartesian theory of perception, or an ecological psychology, that shows a principled basis according to which meaningful relations can take place. A theory such as Darwinism that holds biology and physics or living things and their environments to be incommensurable cannot provide a principled basis for meaningful relations, and, because the evolution of life is distinguished by intentional dynamics or meaningful relations, such a theory is not only deficient with respect an evolutionary epistemology, and an ecological science, but as a theory of evolution in general too.

6) Evolution According To Darwinism Is Defined As a Change In Gene Frequencies, And This Puts Cultural Evolution Outside The Reach Of Darwinian Theory

Clearly cultural evolution, as a consequence of the rate at which it is transforming the planet, is of great interest to those interested in terrestrial evolution in general, as well as ecological science in particular. For evolutionary epistemologists cultural evolution is part of a continuous process of knowledge acquisition, and for human ecology cultural evolution is clearly central to its subject matter. By defining evolution as a change in gene frequencies, however, Darwinian theory can have little to say about cultural evolution at all, which "is not really evolution at all" (Dawkins, 1986, p. 216) under this definition. This is not a mere technical point. The interests of genes, and the interests of "memes" (roughly speaking the ideas that are replicated by cultural systems as their principle hereditary component [Dawkins, 1986; Dennett, 1995]) are incommensurable, and so are biological, and cultural evolution on this view.

Swenson: *Advances in Human Ecology*, Vol. 6, 1997**AUTOCATAKINETICS: A THEORY OF EMBEDDED CIRCLES****Identity Through Flow****Symmetry Breaking And Symmetry Making: Autocatakinesis,
And The Generalized Metabolism Of Dynamic Flow Structures**

An ecological science requires a demonstration of why, contrary to what most evolutionary theorists believe biological and cultural evolution are *not* a negation of physical evolution—a principled basis for uniting the two rivers, or otherwise apparently two-direction universe, that Fisher, and many others have pointed out. It requires answering the question of Lorenz about why, with the fecundity principle, according to which life produces as much order as it can, and with evolution as a whole, the world produces what appears as a progressive process that goes from what appears to be more probable to increasingly less probable states. It needs to show why, if the transition from disorder to order is infinitely improbable, as Boltzmann argued, the world, in effect, is in the order-production business. What is more, it must show the basis for the meaningful relations by which the intentional dynamics of biological and cultural ordering are distinguished.

As noted briefly above, part of the attraction of Descartes' passive, "dead", qualityless world of physics to the proponents of the mechanical world view was that it required extra-physical ordering to get it ordered. The mechanical world, made of inert, reversible, particles incapable of ordering themselves, as Boyle (Lange, 1877/1950, p. 255) pointed out, like the "ingenious clock of Strasburg Cathedral" must have an intelligent artificer to account for it. In addition to Boyle, the argument from design was made repeatedly throughout the rise of modern science. Paley's famous version about finding a watch on a beach, and knowing that it had to have had a watchmaker to design it, is the one Darwin is credited with undermining with the idea of natural selection which Dawkins (1986) has consequently termed the "blind watchmaker". But there is a serious category error in these arguments, namely, that non-artifactual systems, such as living ones, are not the same kinds of things as mechanical artifacts. In different terms, if you found a watch on a beach, or wherever, it certainly would make sense to imagine that it had an artificer to design it because nothing like it has ever been found in the universe as far as anyone knows that was not artifactually produced.

Machines or artifacts are defined by static order—their identity constituted and maintained by static components, the same components, external repairs excluded, in the same positions with respect to each other. Living systems from bacteria to cultural systems, as self-organizing, or spontaneously ordered systems, are defined by dynamic order—their identity is constituted through the incessant flux of their components which are continuously being replaced from raw materials in their environments, and expelled in a more dissipated form. Persistence (the form of the thing) at one level (the "macro" level) is constituted by change at the component level (the "micro" level). In more technical terms, living systems are autocatakinetic systems while artifactual systems are not. The class of autocatakinetic systems includes more than just living systems, and this immediately suggests a connection between living and non-living things that will



Figure 2. A tornado is an example of an autocatakinetic system, a dynamically ordered flow structure whose identity, in contrast to a machine, or artifact, is constituted not by a set of particular components typically occupying fixed positions with respect to each other, but by the ordered relations maintained by the incessant flow of its components. The dynamical order that defines the persistence of an autocatakinetic system as an object at the macro level, is maintained through constant change at the micro level. This incessant flux of components can be thought of as a generalized metabolism by which the system maintains itself by pulling environmental potentials (or resources) into its autocatakinesis, which it returns in a more dissipated form. All living things from bacteria to human cultural systems as well as the planetary system as a whole, which maintains a constant level of oxygen, for example, by this same generalized process, are all members of the class of autocatakinetic systems. Photo courtesy of the National Severe Storms Laboratory.

be more apparent later on. Dust devils, hurricanes, and tornadoes, for example, are all examples of autocatakinetic flow structures whose identities are constituted in just this way<by the incessant flux of matter and energy pulled in from, and then excreted or expelled back into, their environments in a more degraded or dissipated form (see Figure 2). An autocatakinetic system is defined as one that maintains its "self" as an entity constituted by, and empirically traceable to, a set of nonlinear (circularly causal) relations through the dissipation or breakdown of field (environmental) potentials (or resources) in the continuous coordinated motion of its components (from *auto-* "self" + *cata-* "down" + *kinetic*, "of the motion of material bodies and the forces and energy associated therewith" from *kinein*, "to cause to move")(Swenson, 1991a).

The importance of understanding living systems as flow structures with behavior generic to the class was emphasized in the first half of this century by Bertalanffy (e.g., 1952), and later by Schrödinger (1945), who popularized the idea of living things as streams of order which, like flames, constitute themselves by feeding off "negentropy" (energy potentials) in their environments. Prigogine (e.g., 1978) called such systems "dissipative structures". The root of the idea goes back at least to the Presocratic Heraclitus (536 B.C.) who, in contrast to Parmenides, for whom true reality was entirely static, characterized the world as a continual process of transformational flow, and its objects as constituted by a generalized metabolism or combustion. Fire, as Aristotle (1947, p. 182) wrote centuries later in *De Anima*, stressing the active agency and generalized metabolism, consumption, growth, and decay of such systems, "alone of the primary elements [earth, water, air, and fire] is observed to feed and increase itself." In modern times the idea was picked up by Leibniz who, following Heraclitus, described the dynamical persistences of the world as in a state of "perpetual flux, like rivers [where] the parts are continually entering in and passing out" (Rescher, 1967, p. 121). It was first used as part of a general theory of evolution by Spencer (e.g., 1852, 1857/1892, 1962; Swenson, in press-b). Figure 3 shows a schematic of a generalized autocatakinetic system. Circular causality, as

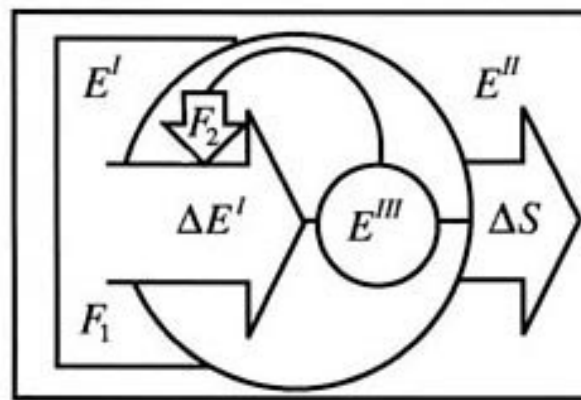

Figure 3. A generalized autocatakinetic system. E^I and E^{II} indicate a source and a sink with the difference between them constituting a field potential with a thermodynamic force F_1 (a gradient of a potential) the magnitude of which is a measure of the difference between them. ΔE^I is the energy flow at the input, the drain on the potential which is transformed into entropy production ΔS at the output. E^{III} is the internal potential carried in the circular relations that define the system by virtue of its distance from equilibrium that acts back to amplify or maintain input during growth or non-growth phases respectively with an internal force F_2 . From "Emergent Attractors and the Law of Maximum Entropy Production: Foundations to a General Theory of Evolution" by R. Swenson, 1989b, *Systems Research*, 6, p. 191. Copyright 1989 by Pergamon. Adapted by permission.

in closed-circle theory, and its various relatives, plays a central role in autocatakinetic systems, but in contrast to the autonomous circular relations of closed-circle theory which refer only to themselves, the circularity that defines an autocatakinetic system defines, and maintains it in relation to its environmental sources. Autocatakinetic systems are embedded circles whose existence is inseparable from their environments both in actuality, and by definition. In contrast to generalized Cartesian or closed circles, the circularity that defines the existence of autocatakinetic systems refers to the autocatakinetic-environment relation. There is no existence or self-reference for an autocatakinetic system independent of this relation. The rest of this section sketches some of the important generic behavior of autocatakinetic systems, and the following section the nomological basis for this dynamical ordering, and the way it is manifested in the intentional dynamics of living things.

Order Production, Symmetry Breaking, And Space-Time Dimensions

Symmetry, simply put, is invariance over change. Something is symmetric under certain operations or transformations if those operations leave it unchanged, it remains the same, or, put differently, is conserved under those operations. The greater the number of symmetry operations that can be performed on a thing to which it is indifferent, or remains unchanged the greater its symmetry. With geometric objects, for example, a sphere has greater symmetry than any other with respect to its rotational symmetry group because it is left invariant under arbitrary rotations around any axis passing through its center. Because these rotations can take on any value, the rotational symmetry group of a sphere is said to be continuous. In contrast, the symmetry group of a cube is discrete rather than continuous, and its symmetry is considerably lower. It is symmetric only under rotations around an axis through its face centers of 90°, 180°, 270°, and 360° (fourfold rotations). As this example shows, discontinuities constitute a break or reduction in symmetry, and from this we see that spontaneous order production, the appearance of an autocatakinetic system where there was none before, constitutes a symmetry-breaking event. There is now an object where there was no object before, and such an object constitutes a discontinuity in the field or environment from which it arises. When a tornado comes into being in a sky where there previously was no tornado it breaks the symmetry of the sky.

This is further illustrated with a classic laboratory example of spontaneous ordering, or self-organization, known as the B é nard experiment (see Figure 4). In this experiment a viscous

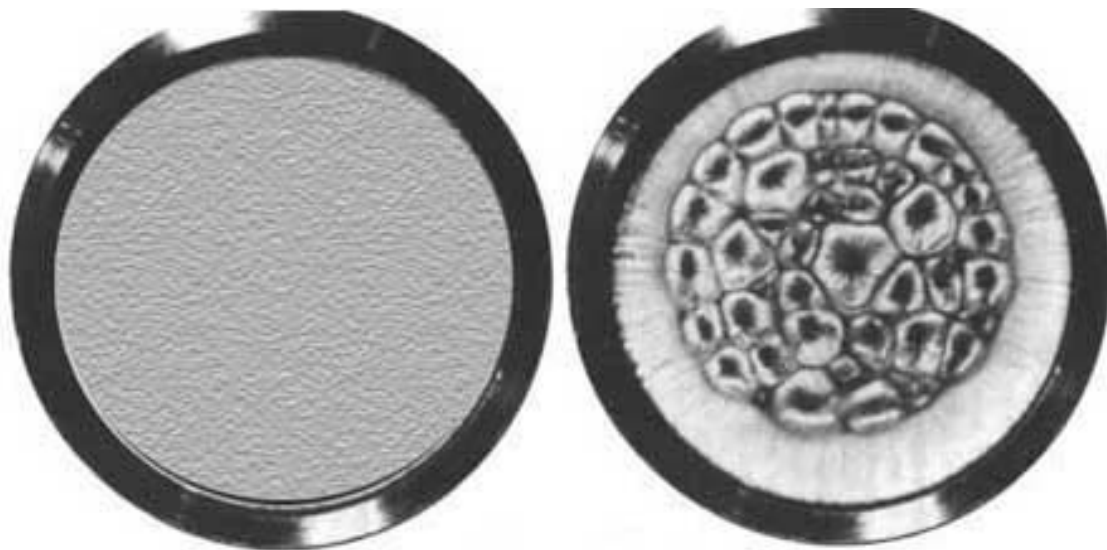

Figure 4. Two time slices from the B ernard experiment. The first time slice (left) shows the homogeneous or disordered "Boltzmann regime" where entropy is produced by heat flow from the disordered collisions of the molecules (by conduction), and the second (right) shows entropy production in the ordered regime. Spontaneous order arises when the field potential is above a minimum critical threshold, and stochastic microscopic fluctuations are amplified to macroscopic levels as hundreds of millions of molecules begin moving in an orderly fashion together. From "Emergent Attractors and the Law of Maximum Entropy Production: Foundations to a Theory of General Evolution" by R. Swenson, 1989b, *Systems Research* 6, p. 192. Copyright 1989 by Pergamon. Reprinted by permission.

fluid (silicone oil) is placed in a dish and heated uniformly from below. As a consequence of the difference in temperature, or gradient, between the hot bottom (source) and the cool air on top (sink) a potential exists which results in a flow of energy as heat from source to sink. Figure 4 shows two time slices from this experiment. The left-hand photo shows the disordered or Boltzmann regime where the potential is below a minimal threshold, and the source-sink flow is produced by the random, or disordered, collisions of molecules. In this regime, the surface of the system is smooth, homogeneous, and symmetrical. Any part can be exchanged with any other without changing the appearance or dynamics of the system at all. When the potential is increased beyond the critical threshold, however, the situation changes dramatically as spontaneous order arises and the symmetry of the disordered regime is broken. The dynamical ordering of the system produces macroscopic discontinuities with distinct space-time orientations that make it no longer possible to arbitrarily exchange one part for another.

The relation between order production, symmetry breaking, and space-time dimensions is an important one, and can be brought further into focus by looking at the B ernard experiment in more detail.

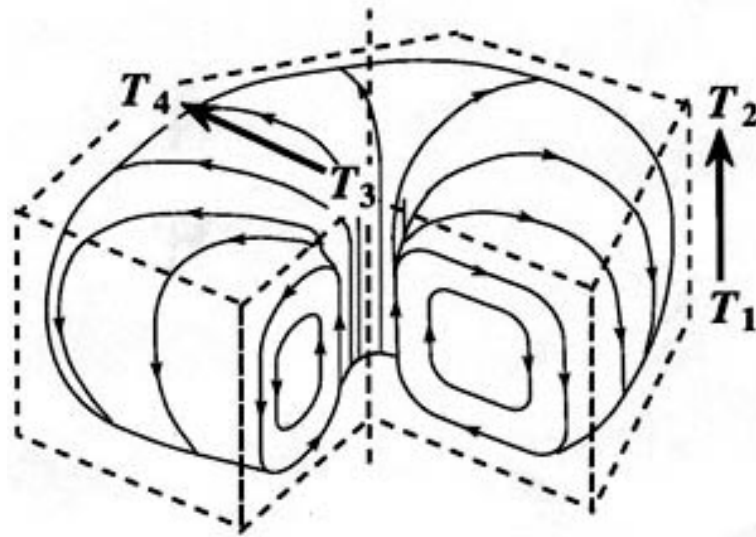

Figure 5. The autocatakinetic flow of the fluid constituting a B é nard cell is shown by the small arrows. $T_1 \rightarrow T_2$ is the heat gradient between the heat source below and the sink above that constitutes the potential that motivates the flow. Because density varies inversely with temperature there is also a density gradient from bottom to top giving groups of molecules ("parcels") that are displaced upwards by stochastic collisions an upward buoyant force. If the potential is above the minimum threshold, parcels will move upward at a faster rate than their excess heat can be dissipated to their surrounds. At the same time such an upward flow of heat will increase the temperature of the upper surface directly above it creating a surface tension gradient $T_2 \rightarrow T_1$ which will act to further amplify the upward flow by pulling the hotter fluid to the cooler surrounds. The upward displacement of fluid creates a vacuum effect pulling more heated fluid from the bottom in behind it which in turns makes room for the fluid which has been cooled by its movement across the top to fall, be heated and carry the cycle on, and autocatakinetic flow has been established. From *Spontaneous, Order, Evolution and Natural Law: An Introduction to the Physical Basis for an Ecological Psychology* by R. Swenson, 1997, Hillsdale, NJ: Lawrence Erlbaum and Associates. Copyright 1997 by Lawrence Erlbaum and Associates. Used by Permission.

Figure 5 shows the ordered autocatakinetic flow of molecules constituting an individual B é nard cell. Here, by way of the stream lines, we can see in detail the way the continuous flow of components at the microscopic level constitutes the structure at the macroscopic level. As this figure helps visualize, because the intrinsic space time dimensions for any system or process are defined by the persistence of its component relations, the transformation from disorder to order increases its dimensions dramatically. Put in different terms, the symmetry breaking that occurs in the production of order from disorder implies a dramatic increase in a system's space-time dimensions.

In the ordered regime of the B é nard experiment the intrinsic space-time dimensions are of the order of seconds and centimeters; it takes the fluid some seconds to make an autocatakinetic cycle between source and sink, and the distance covered, or the dimensions of a single cell, such as that shown in Figure 5, is in numbers of centimeters. This is in stark contrast to the disordered regime where the intrinsic space-time dimensions are defined by mean free path distances and relaxation times (the distances and times between random or disordered collisions), and are on the order of 10^{-8} centimeters and 10-15 seconds. From this it is seen that with the breaking of symmetry in the production of spontaneous order the system accesses, and fills, new dimensions of space-time beyond the reach of its previous regime. The same generic dynamics can be seen with respect to terrestrial evolution in Figure 1. Here, spontaneous ordering occurs at symmetry breaking events as minimal critical thresholds of atmospheric oxygen are reached with the system, as a consequence, progressively filling new dimensions of space-time, and moving, contrary to the Boltzmann interpretation of the second law, increasingly further from thermodynamic equilibrium. This relationship between spontaneous ordering and the filling, or extension of space-time dimensions, as the final section of this paper will show, provides an important piece to the apparent puzzle of the river that flows uphill. From this, evolution on Earth can be seen as a process of symmetry-breaking events by which the terrestrial system as a whole accesses new dimensions of space-time, and moves progressively further from equilibrium. This provides a set of observables that establishes the direction or time-asymmetry of evolution.

Insensitivity to Initial Conditions, Downward Causation, or Macrodeterminacy, And the Genericity of Populations Of One

The preceding sections dealing with closed-circle theory and Darwinism as the theory of evolution

showed a number of major problems, or anomalies, that render both of these approaches inimical to a comprehensive evolutionary theory, an account of intentional dynamics, or the active epistemic dimension of the world, and as a consequence to ecological theory. Given the anti-ecological Cartesian postulates at each of their cores, however, this is inevitable. Neither has a universal embedding, an embedding in a physical world that is commensurable with the behavior they would like to explicate. The study of autocatakinetic systems, on the contrary, which by definition, and by their behavior, namely, that they exist through, as differentiations of, the larger systems or world from which they arise, implies commensurability.

Living systems are a kind of autocatakinetic system. In particular, they are autocatakinetic systems with replicating components. Autocatakinesis, self-organization, or spontaneous ordering, however, is a universal property that is not dependent on, and therefore not explained by replicating components, or, in different terms, by biology, or culture. It is the universality of spontaneous ordering, or autocatakinesis, that provides the basis for understanding the commensurability of all self organizing systems in general. In this subsection, although it is understood that the fact of autocatakinetic systems (*viz.*, the nomological basis for the river that flows uphill in relation to the river that flows down) remains to be explained until the next section, here it will be shown that major problems, or anomalies, of insensitivity to initial conditions, downward causation, and populations of one, are generic properties, and behaviors<everyday expected behavior, and not anomalies, or problems, within the context of autocatakinetic systems.

Real-world systems, particularly, but not by any means exclusively, living things and the intentional dynamics that distinguish them, are remarkably insensitive to initial conditions. Because orthodox theory adheres to an impoverished causal description of the world, namely, that it is essentially microdetermined, it has no basis to admit what amounts to macroscopic causality, or downward causality into its explanatory framework. It is for this same reason that it cannot address the problem of the population of one. Put in simple, and blunt terms, it fails to recognize the universality of autocatakinesis or self-organization, and assumes with its Cartesian postulates, and Boltzmannian thermodynamics, an incommensurable physics. Insensitivity to initial conditions, downward causality, or macrodeterminism is a generic property of autocatakinetic systems. We return to the B é nard experiment, again in more detail for an illustration.

Returning to Figure 4, the right-hand photo shows the system filled with B é nard cells of variable size and shape shortly after the critical threshold has been crossed. As time continues, however, a spontaneous process of selection occurs that includes the subsumption of smaller cells by larger ones, the competitive exclusion of smaller cells by larger ones, and the spontaneous division, or fission, of larger cells to smaller ones (e.g., see Swenson, 1989a, 1989b, 1992, and in press-c, for the time series). The end result is a regular array of hexagonal cells of uniform size and shape. Now, the point to make is that the variability that is seen in Figure 4, which is at the beginning of the process, is a consequence of the fact that order production is stochastically, or randomly, seeded. The end state, however, is macrodetermined.

In particular, in the disordered regime the dynamics are characterized by random collisions between microcomponents which constitute fluctuations around an average state. When the critical threshold is crossed spontaneous order is seeded by any fluctuation anywhere in the fluid that is of a minimal amplitude. Since the location and actual amplitude of such fluctuations is stochastically determined the cells will form at different places in the fluid and grow at different rates every time the experiment is done. Seconds after the critical threshold is crossed the fluid thus fills with cells of variable size, but each and every time the experiment is run the variability in the size and shape is progressively eliminated by a process of selection to produce a final state of regularly arrayed hexagonal

cells of uniform size and shape. In a decidedly non-Laplacian fashion, unlike micro antecedents lead to like macroscopic consequences. Here we see a process of "blind variation" in the stochasticity of the microcomponents in the disordered regime, and a lawful process of selection leading to a macrodeterminate result. Random initial conditions at the micro level do not mean that the evolution of the system is random or undetermined. Initial conditions, which can vary dramatically relative to their own frame of reference, need only meet some minimal general conditions, and the laws of form do the rest.

A number of other generic properties that can be observed in this example bear pointing out. When the critical threshold is reached in the B nard cell experiment, and the fluid fills with cells, every cell arises initially as a population of one. The population of one is not anomalous with respect to autocatakinetics, autocatakinetic systems are populations of one, and the general conditions for the establishment of autocatakinetic systems is generic across scales. In each case it involves 1) stochasticity or "blind variation" at the micro level that "seeds" order at the macro level, 2) circular causality that amplifies the microscopic seeding to establish autocatakinetics at the new macroscopic level, and 3) a source-sink gradient above some minimal critical level sufficient to pump up or fill out the new dimensions of space-time that the establishment and maintenance of autocatakinetics entails. The specific details of the establishment of macroscopic order in the B nard experiment are discussed in the figure legend of Figure 5.

As the generic description implies, autocatakinetic systems are deviation amplifying systems, to use Maruyama's (1963) term. They come into being as a consequence of positive feedback which acts to amplify small deviations or displacements away from thermodynamic equilibrium. Although negative feedback and homeostasis follows naturally from positive feedback as a consequence of various limits to growth or laws of form that follow from the finite nature of space-time, autocatakinetic systems come into being, and are characterized by growth, and the departure from thermodynamic equilibrium. Typically, providing sufficient environmental potential exists, when the system reaches a limit (a critical minimal threshold), order production continues either horizontally, by fissioning, or vertically through the production of a new macroscopic level.

Because autocatakinetic systems are dependent on their surfaces for pulling in environmental potential, and because in isometric growth surfaces increase as the square of a linear dimension while the volume increases as the cube, some form of surface-volume law, or related laws of form, typically determines a minimum and maximum size a system can be before fissioning. Again, fluctuations play an important role in the symmetry breaking process. Below a critical threshold they are dampened, and above, they are amplified. This generic order-producing dynamic is seen from simple physical systems, such as the B nard experiment (see Swenson, 1989a, 1989c, 1992 for photos of fissioning of B nard cells) to bacteria, and through to the autocatakinetics of cultural ordering, and planetary autocatakinetics as a whole.

From the early Paleolithic to early Neolithic times, to see this in a cultural example, the hominid population increased from some few tens of thousands to something like 5-10 million, but not through a corresponding increase in the size of autonomous communities (not by building new levels of order, or vertical ordering or growth), but through the proliferation by fissioning of their number (by horizontal growth) from something like 1500 at the beginning of the Paleolithic to some 75,000 or so at the end (Carneiro, 1987). The fissioning of autonomous villages, given a supply of initial conditions within tolerance, as with the B nard case, is a macrodeterminate process. Below a critical size or threshold, social interactions which can be thought of as fluctuations or deviations from the mean (e.g., adultery, theft, disharmonious acts of witchcraft) are damped. When an autonomous unit exceeds a certain minimal size, however, these same microconditions are amplified to macroscopic proportions and

fissioning occurs. This fissioning was the almost exclusive means of growth of human culture for some ninety-nine percent of its history until suddenly, and within a short period of time, after certain critical environmental thresholds were reached, vertical ordering occurred when previously autonomous units were pulled into the emergence of nation states, not once, but repeatedly and independently in numerous separate locations. As Carneiro (1970, p. 733; 1981; Swenson, 1991b; Swenson & Turvey, 1991) has shown "[w]here the appropriate conditions existed, the state emerged...[and e.g., in the Valley of Mexico, Mesopotamia, the Nile Valley, and the Indus Valley) "the process occurred in much the same way for essentially the same reasons.

Spontaneous Ordering Occurs Whenever it Gets the Chance

Finally, returning once again to the Bé nard experiment to emphasize here perhaps the most important point with respect to spontaneous order production, it is seen that order arises, not infinitely improbably, but with a probability of one, that is, every time, and as soon as, the critical threshold is reached. Spontaneous ordering occurs, in other words, as soon as the opportunity arises. This conforms with the biological extremum (the fecundity principle) that takes it to be the "inherent property" of life to produce as much biological order as it can, and the evolutionary record writ large which suggests that the production of higher-ordered forms, including the origin of life itself occurred, not as a repeated series of astronomically improbable accidents (which certainly would be "infinitely improbable"), but as soon as it had the chance (viz., the origin of life on Earth not after some long lifeless time, but as soon as the Earth was cool enough to support oceans, and the origin of higher-ordered forms as soon as minimal levels of atmospheric oxygen were reached [Figure 1]). If the world in general produces as much order as it can, what is the nomological basis? The answer is given in the next section, which, as a consequence provides the principled basis for unifying the otherwise apparently two incommensurable rivers.

Swenson: *Advances in Human Ecology*, Vol. 6, 1997

WHY THE WORLD IS IN THE ORDER PRODUCTION BUSINESS: THE NOMOLOGICAL BASIS FOR INTENTIONAL DYNAMICS

Symmetry and Broken Symmetry Again: The Classical Statements of the First and Second Laws of Thermodynamics

The insistence of Heraclitus on the importance of persistence and change, and his view of the world as an ongoing process of flow, would certainly seem to qualify him as the foremost ancient progenitor of what would become the science of thermodynamics. Leibniz's assertion that there must be something that changes and something that remains the same, or something conserved, and his very aggressive work to identify the conserved, and active quantities of the world, certainly qualify him as the modern founder of thermodynamics. The work of Mayr, and also Helmholtz, who are credited, among others with formulating the first law can be traced in a direct lineage to Leibniz. One may also locate legitimate roots for the laws of thermodynamics in those who searched for symmetry principles, Parmenides among them, because the first and second laws, understood in the deepest sense, are symmetry principles. Eddington (1929) has argued that the second law holds the supreme position among all the laws of nature, but, it is probably more accurate to say that the first and second laws together hold the supreme positions among all the laws of nature, because they are each dependent in a certain way upon the other.

Following the earlier work of Davy and Rumford, the first law was first formulated by Mayer, then Joule, and later Helmholtz in the first half of the nineteenth century with various demonstrations of the equivalence of heat and other forms of energy. The law was completed in this century with Einstein's demonstration that matter is also a form of energy. With its recognition that all natural processes can be understood as flows or transformations of different forms of energy, and that the total quantity of energy always remains the same, or is conserved, the first law provided the basis for unifying all natural processes through the recognition of their underlying time-translation symmetry. The first law, in other words, expresses what remains the same through all natural processes, regardless which way one goes in time. This presumably would have made Parmenides happy because as far as the first law goes nothing, in effect, changes, or, in other words, there is no time. When the potential energy of an elevated body of water is, by its fall, turned into mechanical energy to drive a mill wheel, and the mechanical energy, in turn, is dissipated into the surrounds as heat from the friction of the millstone, the total amount of energy is conserved, or has remain unchanged, and that is what the first law says ("energy is never created or destroyed" is thus another statement of the first law).

Until Clausius and Thomson (later "Lord Kelvin") came along there was nevertheless some confusion and doubt about this law. This was because, as Joule's experiment (Figure 6) demonstrating the conservation of energy

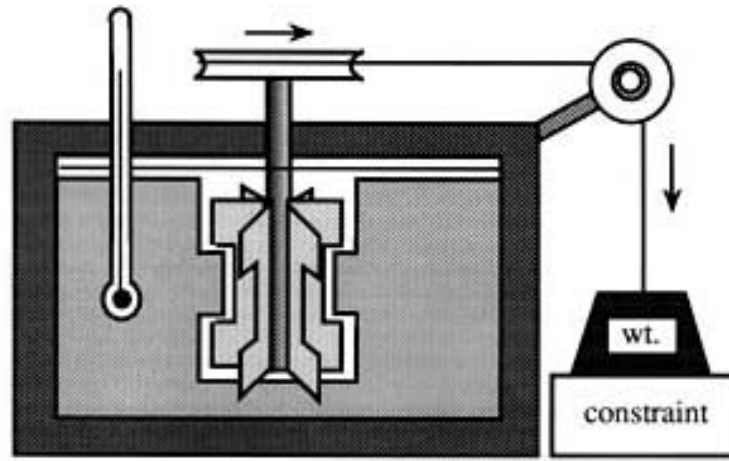

Figure 6. Experiment devised by Joule to show the conservation of energy. When a constraint is removed potential energy in the form of a suspended weight is converted into the mechanical or kinetic energy of a moving paddle wheel in an energy-tight container of water heating the water by an amount consistent with the amount of potential energy lost by the falling weight.

unintentionally showed, for example, there is a broken symmetry to natural processes, a one-way flow of things that, in contrast to the first law, establishes the notion of time, that there is a difference between the past, present, and future. The same is easily seen with the example of the mill wheel.

It was the relation between the symmetry on the one hand, and broken-symmetry on the other that Clausius and Thomson showed with their formulation of the second law in the 1850's. It was the work of Carnot, some twenty-five years earlier, that brought the problem to a head. Carnot had observed that like the fall of a stream that turns a mill wheel, it was the "fall" of heat from higher to lower temperatures that motivated a steam engine. That this work showed an irreversible destruction of "motive force" or potential for producing change suggested to Clausius and Thomson that if the first law was true then energy, contrary to popular misconception, could not be the motive force for change. Recognizing in this way that the active principle and the conserved quantity could not be the same they realized that there must be a second law involved. Clausius coined the word "entropy" to refer to the dissipated potential, and the second law states that all natural processes proceed so as to maximize the entropy (or equivalently minimize or dissipate the potential), while energy, at the same time is entirely conserved. The balance equation of the second law, expressed as $\Delta S > 0$, says that in all real world processes entropy always increases.

The active nature of the second law is intuitively easy to grasp and empirically easy to demonstrate. Figure 7 shows a glass of hot liquid placed in a room at a cooler temperature. The difference in temperatures in the

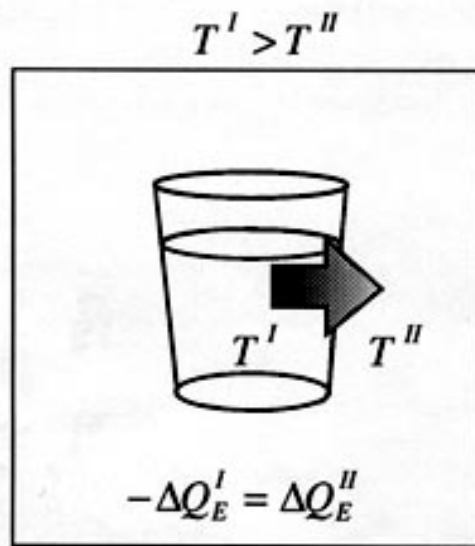

Figure 7. A glass of liquid at temperature T^I is placed in a room at temperature T^{II} such that $T^I > T^{II}$. The disequilibrium produces a *field potential* that results in a flow of energy in the form of heat $-\Delta Q_E^I$ from the glass to the room so as to drain the potential until it is minimized (the entropy is maximized) at which time thermodynamic equilibrium is reached and all flows stop. $-\Delta Q_E^I = \Delta Q_E^{II}$ refers to the conservation of energy in that the flow from the glass equals the flow of heat into the room. From "End Directed Physics and Evolutionary Ordering: Obviating the Problem of the Population of One" by R. Swenson, in F. Geyer (Ed.), *The Cybernetics of Complex Systems: Self-Organization, Evolution, and Social Change*, p. 45, 1991, Salinas, CA: Intersystems Publications. Copyright 1991 Intersystems Publications. Adapted by permission.

glass-room system constitutes a potential and a flow of energy in the form of heat, a "drain" on the potential, is produced from the glass (source) to the room (sink) until the potential is minimized (the entropy is maximized) and the liquid and the room are at the same temperature. At this point, all flows and thus all entropy production stops ($\Delta = 0$) and the system is at thermodynamic equilibrium. The same principle applies to any system where any form of energy is out of equilibrium with its surrounds (e.g., mechanical, chemical, electrical, or energy in the form of heat), a potential exists that the world acts spontaneously to minimize.

The Second Law as a Law of Disorder

The active macroscopic nature of the second law presented a direct challenge to the "dead" mechanical world view which Boltzmann tried to meet by reducing it to a law of probability following from the random collisions of mechanical particles. Following Maxwell, and modeling gas molecules as colliding billiard balls in a box, Boltzmann noted that with each collision nonequilibrium velocity distributions (groups of molecules moving at the same speed and in the same direction) would become increasingly disordered leading to a final state of macroscopic uniformity and maximum microscopic disorder—the state of maximum entropy (where the macroscopic uniformity corresponds to the obliteration of all field potentials). The second law, he argued, was thus simply the result of the fact that in a world of mechanically colliding particles disordered states are the most probable. Because there are so many more possible disordered states than ordered ones, a system will almost always be found either in the state of maximum

disorder<the macrostate with the greatest number of accessible microstates such as a gas in a box at equilibrium<or moving towards it. A dynamically ordered state, one with molecules moving "at the same speed and in the same direction," Boltzmann (1886/1974, p. 20) concluded, is thus "the most improbable case conceivable...an infinitely improbable configuration of energy."

Boltzmann himself acknowledged that his hypothesis of the second law had only been demonstrated for the case of a gas in a box near equilibrium, but the science of his time (and up until quite recently) was dominated by linear, near-equilibrium or equilibrium thinking, and this view of the second law, as a law of disorder, became widely accepted. The world, however, is not a linear, near equilibrium system like a gas in a box, but instead nonlinear and far-from-equilibrium, and the second law is not reducible to a stochastic collision function. As the next subsection section outlines, rather than being infinitely improbable, we now can see that spontaneous ordering is the expected consequence of natural law.

Why the World is in the Order-Production Business

The idea that living things violate the second law of thermodynamics was temporarily deflected in the middle of this century when Bertalanffy (e.g., 1952, p. 145) showed that "spontaneous order...can appear in [open] systems" (systems with energy flows running through them) by virtue of their ability to build their order by dissipating potentials in their environments. As briefly noted above, along the same lines, pointing to the balance equation of the second law, Schrödinger (1945) popularized the idea of living things a streams of order which like flames are permitted to exist away from equilibrium because they feed on "negentropy" (potentials) in their environments, and these ideas were further popularized by Prigogine (e.g., 1978).

Schrödinger's important point was that as long as living things like flames (and all autocatakinetic systems) produce entropy (or minimize potentials) at a sufficient rate to compensate for their own internal ordering or entropy reduction (their ordered departure and persistence away from equilibrium), then the balance equation of the second law, which simply says that entropy must increase in all natural processes, would not be violated. According to the Bertalanffy-Schrödinger-Prigogine view, order *can* arise spontaneously, and living things are thus *permitted* to exist, as it became popular to say, as long as they "pay their entropy debt." While this made an important contribution to the discourse, and worked for the classical statement of the second law per Clausius and Thomson, on Boltzmann's view such "debt payers" were still infinitely improbable. Living things were still infinitely improbable states struggling, or fighting, against the laws of physics. The urgency towards existence captured in the fecundity principle and the intentional dynamics it entails, as well as planetary evolution as a whole were still entirely anomalous on this view with respect to universal law. What is more, as the B é nard experiment shows, simple physical systems also falsify the Boltzmann hypothesis. Order is seen to arise, not infinitely improbably, but with a probability of one, that is, whenever, and as soon as it gets the chance. The nomological basis for this opportunistic ordering was still a mystery, a point emphasized by Bertalanffy himself, who suspected there might be another thermodynamic principle that would account for this "build-upism", or, in the terms we have been using, the river that flows uphill.

Space-Time Relations, Order Production, and a Return to the Balance Equation of the Second Law

There are two key pieces to solving the puzzle or problem of the two incommensurable rivers. The first is discovered by a return to the balance equation of the second law. As discussed above, and illustrated in Figure 5, transformations from disorder to order dramatically increase the space-time dimensions of a system. What Bertalanffy and Schrödinger emphasized was that as long as an autocatakinetic system produces entropy fast enough to compensate for its development and maintenance away from equilibrium (its own internal entropy reduction or increase in space-time dimensions), it is permitted to exist. Ordered flow, in other words, to come into being or exist must function to increase the rate of entropy production of the system plus environment at a sufficient rate < must pull in sufficient resources and dissipate them < to satisfy the balance equation of the second law. This makes an important point implicitly, that was not specifically noted by Bertalanffy or Schroedinger, that will now be stated explicitly: *Ordered flow must be more efficient at dissipating potentials than disordered flow* (Figure 5 shows exactly how this works in a simple physical system). Figure 8 which shows the dramatic increase in the rate of heat transport from source to sink that occurs in the transformation

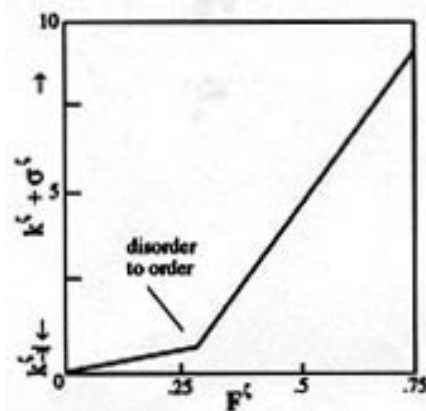

Figure 8. The discontinuous increase in the rate of heat transport that follows from the disorder-to-order transition in a simple fluid experiment similar to that shown in Figure 4. The rate of heat transport in the disordered regime is given by k^L , and $k^L + \sigma$ is the heat transport in the ordered regime [$3.1 \times 10^4 H(\text{cal} \times \text{cm}^{-2} \times \text{sec}^{-1})$]. From "Engineering Initial Conditions in a Self-Producing Environment" by R. Swenson, in M. Rogers and N. Warren (Eds.), *A Delicate Balance: Technics, Culture and Consequences* (p. 70), 1989a, Los Angeles: Institute of Electrical and Electronic Engineers (IEEE). Copyright 1989 IEEE. Reprinted by permission.

from the disordered to ordered state bears this out, and given the balance equation of the second law, it could not be otherwise. This important point brings us to the second and final piece of the puzzle.

The Law of Maximum Entropy Production

The crucial final piece to the puzzle of the two rivers, the piece that provides the nomological basis for dissolving the postulates of incommensurability, is the answer to a question that classical thermodynamics never asked. The classical statement of the second law says that entropy will be maximized, or potentials minimized, but it does not ask or answer the question of which out of available paths a system will take to accomplish this end. The answer to the question is that *the system will select the path, or assembly of paths, out of otherwise available paths, that minimize the*

potential or maximize the entropy at the fastest rate given the constraints. This is a statement of the *law of maximum entropy production* the physical principle that provides the nomological basis, as will be seen below, for why the world is in the order production business (Swenson, 1988, 1991, 1992, 1996; Swenson & Turvey, 1991). Note that the law of maximum entropy production is in addition to the second law. The second law says only that entropy is maximized while the law of maximum entropy production says it is maximized (potentials minimized) at the fastest rate given the constraints. These are two separate laws because the second, in principle, could be falsified without changing the first. Like the active nature of the second law, however, the law of maximum entropy production is intuitively easy to grasp and empirically demonstrate.

Consider the example of the warm mountain cabin sitting in cold, snow-covered woods (Swenson & Turvey, 1991). The difference in temperature between the cabin and the woods constitutes a potential and the cabin-woods system as a consequence will produce flows of energy as heat from the cabin to the woods so as to minimize the potential. Initially, supposing the house is tight, the heat will be flowing to the outside primarily by conduction through the walls. Now imagine opening a window or a door, and thus removing a constraint on the rate of dissipation. What we know intuitively, and can confirm by experiment, is that whenever a constraint is removed and a new path or drain is provided that increases the rate at which the potential is minimized the system will seize the opportunity. Furthermore, since the opened window, for example, will not instantaneously drain all the potential some will still be allocated to conduction through the walls. Each path will drain all that it can, the fastest (in this case the open window) procuring the greatest amount with what is left going to the slower paths (in this case conduction through the walls). In other words, regardless the specific conditions, or the number of paths or drains, the system will automatically select the assembly of paths from among those otherwise available so as to get the system to the final state, to minimize or drain the potential, at the fastest rate given the constraints. This is the essence of the law of maximum entropy production. Now what does this have to do with spontaneous ordering, with the filling of dimensions of space-time?

Given the preceding, the reader may have already leaped to the correct conclusion. **If** the world selects those dynamics that minimize potentials at the fastest rate given the constraints (the law of maximum entropy production), **and if** ordered flow is more efficient at reducing potentials than disordered flow (derivation from the balance equation of the second law), **then** *the world can be expected to produce order whenever it gets the chance* (the world is in the order-production business because ordered flow produces entropy faster than disordered flow (Swenson, 1988, 1991, 1992, 1996; Swenson & Turvey, 1991). Contrary to the older Boltzmann view where the production of order is seen as infinitely improbable, given this new understanding the world can be expected to produce as much order as it can, to expand space-time dimensions whenever the opportunity arises. Autocatakinetic systems, in other words, are self-amplifying sinks that by pulling potentials or resources into their own development and persistence away from equilibrium extend the space-time dimensions of the fields (system plus environment) from which they emerge and thereby increase the dissipative rate. The law of maximum entropy production, when coupled with the balance equation of the second law, provides the nomological basis for dissolving the postulates of incommensurability, and unifying living things with their environments (for unifying the two otherwise apparently incommensurable rivers that flow up and downhill respectively. Rather than an incommensurable, inexplicable, and infinitely improbable anomaly, the river that flows uphill, the active ordering that characterizes terrestrial evolution of which biological, and cultural evolution are parts, is seen to be an expected manifestation of universal law.

Swenson: *Advances in Human Ecology*, Vol. 6, 1997

End-directed Behavior Dependent on Meaning

There is an extremely important property of the intentional dynamics of living things, of the river that flows uphill, that remains to be addressed. At the beginning of this paper intentional dynamics was defined as end-directed behavior prospectively controlled, or determined by meaning, or information, about paths to ends, and this was contrasted with end-directed behavior which can be understood as determined by local potentials, and fundamental laws. Examples of the latter were a river flowing down a slope, or heat flowing down a gradient. We can elaborate this discussion, given what we have covered in the interceding pages, by including examples of autocatakinetic systems, for example, such as the B nard experiment, tornadoes, and dust devils, systems that we call self-organizing, but we do not say are characterized by intentional dynamics. The autocatakinetic systems, which breaks symmetry with previously disordered regimes to access and dynamically fill higher-ordered dimensions of space time, is still determined with respect to local potentials with which they typically remains permanently connected. The autocatakinetic systems of living things, in contrast, is maintained with respect to non-local potentials, potentials discontinuously located in space-time to which they are not permanently connected (Swenson, 1991b, Swenson in press-a; Swenson & Turvey, 1991).

If we understand from universal principles that the world acts, in effect, to maximize its extension into space-time, to produce as much order as possible, we can see immediately what intentional dynamics provide. By providing the means for linking together or accessing and dissipating, discontinuously located, or non-local, potentials in the building of order, intentional dynamics provides access to vast regions of space-time otherwise inaccessible. Just as there is a qualitative leap in the transformation of disorder to order, intentional dynamics, with respect to the potentially accessible dimensions of space-time it offers, constitutes a symmetry-breaking or qualitative leap in terrestrial order production. Likewise, the origin of human cultural systems, which, with highly developed symbolic language, provides what may be thought of as intentional dynamics about intentional dynamics, and with it dramatic access to new dimensions of space-time, was also a terrestrial symmetry breaking event (see also Dyke's [this volume] discussion on the increase of space-time dimensions in human cultural systems).

In the section on evolution, it was shown that the assertion of evolutionary epistemologists that evolution constitutes a progressive knowledge acquisition process from amoeba to Einstein was an assertion that could not be made (nor accounted for) from the ground of Darwinian theory. According to Darwinian theory amoebae and Einsteins are incommensurable, and hence like Kuhnian paradigms, or generic closed-circles, incomparable. It was pointed out that evolution would have to be about something other than fitness to make the assertion that evolutionary epistemologists would like to make. Our understanding that from a universal standpoint terrestrial evolution is a planetary process about entropy production maximization, and as a consequence the filling of space-time dimensions, provides the principled basis to make the assertion. Terrestrial evolution is indeed a progressive knowledge acquisition process from amoeba to Einstein (more appropriately from Archean prokaryotes to the contemporary globalization of human culture), and what the system is learning, in effect, is the accessing of space-time dimensions.

But now the part that still needs explaining: If intentional dynamics are not determined by local potentials, then how are they determined? To simply say that they are meaningfully determined, at this point, begs the question. Autocatakinetics has the property of insensitivity to initial conditions, or macrodeterminacy, but what is the basis for the macrodeterminacy of intentional systems if not local potentials? The Bénard convection, which, in effect, "solves the packing problem" by producing a regular array of hexagonal cells during the course of its evolution or development can be understood in terms of the system's proximal relation to, or embeddedness within, a field of local potentials, but how is intentional behavior determined with respect to non-local or distal potentials? How does it solve the packing problem with respect to non-local potentials? What is the physical basis for the epistemic relations by which the accessibility of new space-time levels of order are effectively opened up? How, in other words, does one get from an otherwise meaningless world of extension, or usual physical description, to a meaningful world of intension, or information about?

From Extension to Intension

We return to our "first principles", in particular, first-law symmetry, second-law broken symmetry, and the law of maximum entropy production as ordering principle, for immediate clues. First, we recognize that, consistent with thermodynamic inquiry, the search here is for macroscopic observables. Autocatakinetic systems are macroscopic systems, embedded in macroscopic flow, and the search is thus not for "meaning" in individual particles, but macroscopic flow variables that capture invariant properties with relevance to intentional ends. Following the same methodology suggests further that the search for macroscopic observables involves a search for symmetry and broken symmetry for observables that capture the nomological relation between persistence and change of the distal objects of intention with respect to the proximal or local space-time position of the epistemic subject. It turns out this is exactly the insight of Gibson's (1979/1986; Swenson & Turvey, 1991; Turvey & Shaw, 1995) ecological conception of information. The idea developed by Gibson with respect to animals and their environments, has now been extended to life in general, and embedded in a universal thermodynamic context by "neo Gibsonians," and, or "third-wave Gibsonians" (e.g., Peck, in press; Swenson in press-a; Swenson & Turvey, 1991; Turvey & Shaw, 1995). The core idea is deceptively simple, but has profound explanatory consequences.

Living things are embedded in ambient energy flows (e.g., optical, mechanical, chemical) for which the mean energy content is extremely low relative to the energy used by living things from their on-board potentials to power their intentional acts. As a consequence of first-law symmetry, lawful or invariant relations exist between the macroscopic properties of such ambient energy distributions, and their sources, with the further consequence that the former can be used in the prospective control of intentional ends to specify or determine the latter. A chemical gradient that lawfully specifies the source of their food can be used by bacteria, diffusion fields of diffusing volatiles that lawfully specify the sources of their intentional ends may be used by animals, and fields of mechanical waves and optical fields can be used in similar ways.

A particularly crucial and widespread requirement for the intentional dynamics of many living things, for example, is the ability to effect controlled collisions (e.g., soft collisions with little or no momentum exchange as in a bird landing on a branch, hard collisions with substantial momentum exchange as when a predator attacks a prey, and collision avoidance where the ends of an intentional agent require that it not collide with particular things). The fact of first-law symmetry means that "information about" such collisions is lawfully carried in the ambient energy field (the "optical flow

field") that transforms itself as a living thing moves through it. Just as in the B é nard case where local potentials, and laws of form specify the origin, production, and development of order, so too with non-local potentials and the invariant or epistemic properties of ambient energy flows with respect to intentional dynamics.

Following the case of controlled collisions further, for example, the time-to-contact (τ), as shown in Figure 9, is determined by the inverse of the relative rate of expansion of the optical flow field, and the information

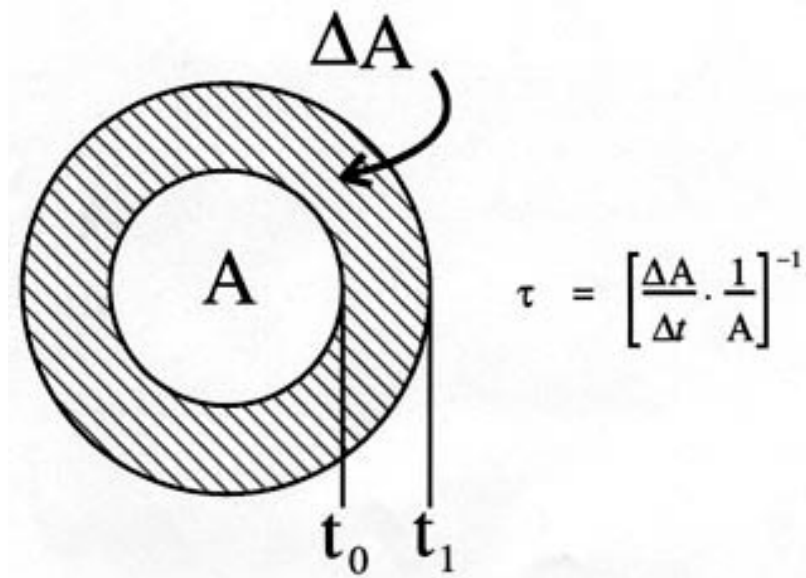

Figure 9. Time-to-contact, τ , is determined by the inverse of the relative rate of expansion of the optical flow field, A .

information about whether a collision will be hard or soft is given by the time derivative or rate of change of the relative rate of expansion ($\dot{\tau}$) (Lee, 1980; Kim et al. 1993). In the case of a bird landing on a branch, and requiring a soft collision, for example, the rate of change must be $\dot{\tau} \approx -0.5$. This example shows how a single macroscopic variable nomologically carried in the optic flow, can precisely determine the intentional dynamics of living things, in this case when a particular bird, for example, must open its wings to decelerate now so that it does not, in effect, crash into a branch later. This deceptively simple understanding exposes the fact that, not only are the shapes and forms things assume nomologically determined by laws of form (e.g., that there is, within tolerance, a requisite ratio between flight muscle weight and body weight, or between wing span and body weight, or brain weight and body weight [e.g., Alexander, 1971]), but that information about or meaning carried in macroscopic flow variables nomologically determines the behavior of things towards their intentional ends.

CONCLUSION

Ecological science addresses the relations of living things to their environments, and the study of human ecology the particular case of humans. There is an opposing tradition built into the foundations of modern science of separating living things, and, in particular, humans from their environments. Beginning with Descartes' dualistic world view, this tradition found its way into

biology by way of Kant, and evolutionary theory through Darwin, and manifests itself in two main postulates of incommensurability, the incommensurability between psychology and physics (the "first postulate of incommensurability"), and between biology and physics (the "second postulate of incommensurability").

The idea of the incommensurability between living things and their environments gained what seemed strong scientific backing with Boltzmann's view of the second law of thermodynamics as a law of disorder according to which the transformation of disorder to order was said to be infinitely improbable. If this were true, and until very recently it has been taken to be so, then the whole of life and its evolution becomes one improbable event after another. The laws of physics, on this view, predict a world that should be becoming more disordered, while terrestrial evolution is characterized by active order production. The world, on this view, seemed to consist of two incommensurable, or opposing "rivers", the river of physics which flowed down to disorder, and the river of biology, psychology, and culture, which "flowed up", working, it seemed, to produce as much order as possible.

As a consequence of Boltzmann's view of the second law, evolutionary theorists, right up to present times, have held onto the belief that "organic evolution was a negation of physical evolution" (Levins & Lewontin, 1985, p. 69), and that biology and culture, work somehow to "defy" the laws of physics (Dennett, 1995). With its definition of evolution as an exclusively biological process, Darwinism separates both biology and culture from their universal, or ecological, contexts, and advertises the Cartesian postulates of incommensurability at its core, postulates that are inimical to the idea of ecological science. An ecological science, by definition, assumes contextualization or embeddedness, and as its first line of business wants to know what the nature of it is. This requires a universal, or general theory of evolution which can uncover, and explicate the relationship of the two otherwise incommensurable rivers, and put the active ordering of biological, and cultural systems, of terrestrial evolution as a time-asymmetric process, back into the world.

The law of maximum entropy production, when coupled with the balance equation of the second law, and the general facts of autocatakinetics, provides the nomological basis for such a theory, and shows why, rather than living in a world where order production is infinitely improbable, we live in and are products of a world, in effect, that can be expected to produce as much order as it can. It shows how the two, otherwise incommensurable, rivers, physics on the one hand, and biology, psychology, and culture on the other, are part of the same universal process and how the fecundity principle, and the intentional dynamics it entails, are special cases of an active, end-directed world opportunistically filling dynamical dimensions of space-time as a consequence of universal law. The epistemic dimension, the urgency towards existence, in Leibniz's terms, characterizing the intentional dynamics of living things and expressed in the fecundity principle, and the process of evolution writ large as a single planetary process, is thus not only commensurable with first, or universal, principles, but a direct manifestation of them.

The view presented here, thus provides a principled basis for putting living things, including humans, back in the world, and recognizing living things and their environments as single irreducible systems. It provides the basis for contextualizing the deep and difficult questions concerning the place of humans, as both productions, and producers, of an active, and dynamic process of terrestrial evolution, which, as a consequence of the present globalization of culture is changing the face of the planet at a rate which seems to be without precedent over geological time. Of course, answers to questions such as these always lead to more questions, but such is the nature of the epistemic process we call life.

ACKNOWLEDGEMENTS

Special thanks as always to the Center for the Ecological Study of Perception and Action and especially to Claudia Carello, Michael Turvey, and Bob Shaw for their work in providing an extraordinary environment conducive to the development of these ideas. Special thanks also to Lee Freese, Series Editor, and also Chuck Dyke for their perseverance in seeing that this article was brought to fruition. Preparation of this manuscript was supported in part by the National Science Foundation Grant # SBR9422650. All errors are mine.

NOTES

1. In fact, Descartes (1644/1975), recognizing the necessity of a conservation principle for a law-based world proposed the conservation of "motion," which he thought would still allow him to get around the problem of interactionism. He thought "mind" could interact with "matter" by changing its direction but not the quantity of motion. Motion, as Leibniz (1696/1925), pointed out, however, is not a conserved quantity. It is momentum which is conserved, and momentum is a vector the conservation of which, like the conservation of energy, would be violated by exogenous interaction.
2. It was Tait who first pointed out how counterintuitive it was to refer to the dissipated potential of a system as a quantity that increased, and he proposed reversing the sign so it would be possible to talk about entropy as the potential for change and thus being minimized. Maxwell picked up on this, but it never caught on. Because the idea of entropy increase is oftentimes hard to conceive, in this text I will often use "minimize the potential" in addition to or instead of "maximize the entropy". They should be taken as equivalent expressions.
3. Since its coinage by Clausius to refer to the dissipated potential in a system the word "entropy" has taken on numerous, and non-physical, as well as subjective, or observer-dependent quantities (e.g., Shannon's information "entropy") where the "entropy" of a system depends on what an individual knows about it. The reader should be aware that some authors illegitimately conflate these meanings. In the present paper, to be clear, the word entropy is used in its physical thermodynamic sense as defined.

REFERENCES

- Alexander, R. 1971. *Size and Shape*. London: William Clowes & Sons, Ltd.
- Aristotle 1947. "De anima." Pp. 163-329 in R. McKeon, ed., *Introduction to Aristotle*. New York: Random House.
- Bertalanffy, L. von 1952. *Problems of Life*. London: Watts.
- Boltzmann, L. 1974. "The Second Law of Thermodynamics." Pp. 13-32 in S.G. Brush, transl., *Theoretical Physics and Philosophical Problems*. Boston: D. Reidel Publishing. First published in 1886.
- Bramwell, A. 1989. *Ecology in the 20th Century: A History*. New Haven: Yale University Press.
- Callebaut, W. & Pinxten, R., eds. 1987. *Evolutionary Epistemology: A Multiparadigm Program*. Dordrecht: D. Reidel Publishing Company.
- Calvin, W. 1986. *The River That Flows Uphill: A Journey from the Big Bang to the Big Brain*. New York: Macmillan Publishing Company
- Campbell, D.T. 1987. "Evolutionary Epistemology." Pp. 47-89 in G. Radnitzky and W.W. Bartley III, eds., *Evolutionary Epistemology, Rationality, and the Sociology of Knowledge*. La Salle, IL: Open Court.

- Carneiro, R. 1970. "A Theory of the Origin of the State." *Science*, 169: 733-738.
- Carneiro, R. 1981. "The Chiefdom: Precursor of the State." Pp. 37-79 in G. Jones and R. Kautz, eds., *The Transition to Statehood in the New World*. Cambridge: Cambridge University Press.
- Carneiro, R. 1987. "Village Splitting as a Function of Population Size." Pp. 94- 124 in L. Donald, ed., *Themes in Ethnology and Culture History, Essays in Honor of David F. Aberle*. Meerut, India: Archana Publications.
- Cloud, P. 1988. *Oasis in Space: Earth History from the Beginning*. New York: Norton.
- Darwin, C. 1937. *On the Oigin of Species by Means of Natural Selection or the Preservation of Favored Races in the Struggle for Life*. New York: D. Appleton-Century Company, Inc. First published in 1859.
- Dawkins, R. 1989. *The Selfish Gene*. Oxford: Oxford University Press. First published in 1976.
- Dawkins, R. 1982. *The Extended Phenotype*. San Francisco: Freeman.
- Dawkins, R. 1986. *The Blind Watchmaker*. New York: Freeman.
- Dennett, D. 1995. *Darwin's Dangerous Idea*. New York: Simon & Schuster.
- Depew, D. & Weber, B. 1995. *Darwinism Evolving*. Cambridge, MA: MIT Press.
- Descartes, R. 1975. "Conservation of Quantity of Motion." Pp. 234-266 in R. Lindsay, ed., *Energy: Historical Development of the Concept*, Benchmark Papers On Energy, Vol. 1. Stroudsburg, PA: Dowden, Hutchinson & Ross. First published in 1644.
- Descartes, R. 1986. *Discourse on Method and Meditations* . L. Lafleur, trans. New York: Macmillan. First published in 1637.
- Dyke, C. in press. Heuristics for ecological interaction. *Advances in Human Ecology* (this volume).
- Eddington, A. 1958. *The Nature Of The Physical World*. Ann Arbor, MI: Ann Arbor Paperbacks.
- Fisher, R.A. 1958. *The Genetical Theory of Natural Selection*. New York: Dover. First published in 1930.
- Gibson, J. J. 1986. *The Ecological Approach to Visual Perception*. Hillsdale, N.J.: Lawrence Erlbaum Associates. First published in 1979.
- Gould, S.J. 1989. *Wonderful life: The Burgess Shale and the Nature of History*. New York: W.H. Norton & Company.
- Kim, N., Turvey, M.T., & Carello, C. 1993. "Optical Information About the Severity of Upcoming Collisions." *Journal of Experimental Psychology*, 19(1): 179-193.
- Lange, F. 1950. *The History of Materialism*. New York: The Humanities Press. First published in 1877.
- Lee, D. 1980. "A Theory of Visual Control of Braking Based on Information about Time-to-Collision." *Perception*, 5: 437 459.
- Leibniz 1925. "Explanation of the New System of Communication Between Substances, by Way of Reply to What is said about it in the Journal of September 12, 1695." Pp. 319-330 in R. Latta, trans., *The Monodology and other Philosophical Writings*. London: Oxford University Press. First published in 1696.
- Leibniz 1969. "On the Radical Origination of Things." Pp. 486 491 in L.E. Loemker, ed., *G.W. Leibniz Philosophical Papers and Letters*. Dordrecht- Holland: D. Reidel Publishing Company. First published in 1697.
- Leibniz 1953. "Monodology." Pp. 249-272 in G. Montgomery, transl., *Leibniz*. La Salle, IL: Open Court Publishing Company. First published in 1714.
- Levins, R. & Lewontin, R. 1985. *The Dialectical Biologist*. Cambridge, MA: Harvard University Press.
- Lewontin, R. 1992. *Biology as Ideology: The Doctrine of DNA*. New York: Harper Collins.

- Lorenz, K. 1973. *Behind the Mirror: A Search for a Natural History of Human Knowledge*. New York: Harcourt Brace Jovanovich.
- Maruyama, M. 1963. "The Second Cybernetics: Deviation Amplifying Mutual Causal Processes." *American Scientist* 51: 164-179.
- Margulis, L. 1982. *Symbiosis in Cell Evolution*. San Francisco: Freeman.
- Margulis, L. & Lovelock, J. 1974. "The Biota as Ancient and Modern Modulator of the Earth's Atmosphere." *Tellus*, 26:1-10.
- Margulis, L. & Sagan, D. 1995. *What is Life?* New York: Simon & Shuster.
- Maynard-Smith, J. 1988. "Evolutionary Progress and Levels of Selection." Pp. 219-230 in M. Nitecki, ed., *Evolutionary Progress*. Chicago, IL: University of Chicago Press.
- Mayr, E. 1980. "Prologue: Some Thoughts on the History of the Evolutionary Synthesis." Pp. 1-48 in E. Mayr and W.B. Provine, eds., *The Evolutionary Synthesis*. Cambridge, MA: Harvard University Press.
- Mayr, E. 1985. "How Biology Differs from the Physical Sciences." Pp. 43-63 in D. Depew and B. Weber, eds., *Evolution at a Crossroads*. Cambridge, MA: MIT Press.
- Munz, P. 1985. *Our Knowledge of the Growth of Knowledge: Popper or Wittgenstein?* London: Routledge & Kegan Paul.
- Munz, P. 1987. "Philosophy and the Mirror of Rorty." Pp. 345-387 in G. Radnitzky and W.W. Bartley, eds., *Evolutionary Epistemology, Rationality, and the Sociology of Knowledge*. La Salle, IL: Open Court.
- Peck, A.J. in press. "Hydrodynamics, Reactive Forces, and the Autocatakinetics of Hearing." *Ecological Psychology*.
- Popper, K. 1985. *Unended Quest: An Intellectual Autobiography*. La Salle, IL: Open Court.
- Popper, K. 1987. "Natural Selection and the Emergence of Mind." Pp. 139-154 in G. Radnitzky and W.W. Bartley III, eds. *Evolutionary Epistemology, Rationality, and the Sociology of Knowledge*. La Salle, IL: Open Court.
- Prigogine, I. 1978. "Time, Structure, and Fluctuations." *Science*, 201: 777-785.
- Radnitzky, G. & Bartley, W.W. III, eds. 1987. *Evolutionary Epistemology, Rationality, and the Sociology of Knowledge*. La Salle, IL: Open Court.
- Rescher, N. 1967. *The Philosophy of Leibniz*. Englewood Cliffs: Prentice-Hall, Inc.
- Salthe, S. 1985. *Evolving Hierarchical Systems*. New York: Columbia University Press.
- Salthe, S. 1994. *Evolution and Development*. Cambridge, MA: MIT Press.
- Schrödinger, E. 1945. *What is Life?* New York: Macmillan.
- Schwartzman, D., Shore, S., Volk, T. & McMenamin, M. 1994. "Self-Organization of the Earth's Biosphere Geochemical or Geophysiological?" *Origins of Life and Evolution of the Biosphere* 24: 435-450.
- Schweber, S. 1985. "The wider British Context of Darwin's Theorizing." Pp. 35-69 in D. Kohn, ed., *The Darwinian Heritage*. Princeton, NJ: Princeton University Press.
- Spencer, H. 1852. "The Social Organism". *Westminster Review* 57:468-501.
- Sober, E. 1984. *The Nature of Selection: Evolutionary Theory in Philosophical Focus*. Cambridge, MA: Bradford Books.
- Spencer, H. 1892. "Progress, Its Law and Cause." Pp. 8-38 in H. Spencer, *Essays: Scientific, Political, and Speculative*. New York: D. Appleton and Company. First published in 1857.
- Spencer, H. 1862. *First Principles*. London: Williams and Norgate.
- Swenson, R. 1988. "Emergence and the Principle of Maximum Entropy Production: Multi-Level System Theory, Evolution, and Non-Equilibrium Thermodynamics." *Proceedings of the 32nd*

Annual Meeting of the International Society for General Systems Research, 32.

Swenson, R. 1989a. "Engineering Initial Conditions in a Self Producing Environment." Pp. 68-73 in M. Rogers and N. Warren, eds., *A Delicate Balance: Technics, Culture and Consequences* (IEEE Catalog No. 89CH2931-4). Los Angeles: Institute of Electrical and Electronic Engineers.

[Swenson, R. 1989b. "Emergent Evolution and the Global Attractor: The Evolutionary Epistemology of Entropy Production Maximization." *Proceedings of the 33rd Annual Meeting of the International Society for the Systems Sciences* 33\(3\): 46-53.](#)

Swenson, R. 1989c. "Emergent Attractors and the Law of Maximum Entropy Production." *Systems Research* 6:187-1987.

Swenson, R. 1990. "Evolutionary Systems and Society." *World Futures*, 30: 11- 16.

Swenson, R. 1991a. "End-Directed Physics and Evolutionary Ordering: Obviating the Problem of the Population of One." Pp. 41-60 in F. Geyer, ed., *The Cybernetics of Complex Systems: Self-Organization, Evolution, and Social Change*. Salinas, CA: Intersystems Publications.

[Swenson, R. 1991b. "Order, Evolution, and Natural Law: Fundamental Relations in Complex System Theory." Pp. 125 148 in C. Negoita, ed., *Cybernetics and Applied Systems*. New York: Marcel Dekker Inc.](#)

Swenson, R. 1992. "Autocatakinetics, Yes<Autopoiesis, No: Steps Towards a Unified Theory of Evolutionary Ordering." *International Journal of General Systems*, 21(2): 207-228.

[Swenson, R. 1996. "Thermodynamics and Evolution." In G. Greenberg and M. Haraway, eds., *The Encyclopedia of Comparative Psychology*. New York: Garland Publishers, Inc.](#)

Swenson, R. in press-a. "Spontaneous Order, Evolution, and Autocatakinetics: The Nomological Basis for the Emergence of Meaning." In G. van de Vijver, S. Salthe, and M. Delpos, eds., *Evolutionary Systems*.

[Swenson, R. in press-b. "Evolutionary Theory Developing: The Problem\(s\) with 'Darwin's Dangerous Idea'." *Ecological Psychology*.](#)

Swenson, R. in press-c. *Spontaneous Order, Evolution, and Natural Law: An Introduction to the Physical Basis for an Ecological Psychology*. Hillsdale, NJ: Lawrence Erlbaum and Associates.

[Swenson, R. and Turvey, M.T. 1991. "Thermodynamic Reasons for Perception- Action Cycles." *Ecological Psychology*, 3\(4\): 317-348.](#)

Turner, J. & Maryanski, A. 1979. *Functionalism*. Menlo Park, CA: Benjamin/Cummings.

Turvey, M.T. & Shaw, R.E. 1995. "Towards an Ecological Physics and a Physical Psychology." Pp. 144-169 in R. Solso and D. Massero, eds., *The Science of the Mind: 2001 and Beyond*. Oxford: Oxford University Press.

Vernadsky, V. 1986. *The Biosphere*. London: Synergetic Press. First published in 1929.

Williams, G. 1992. *Natural Selection*. Oxford: Oxford University Press.